

Access® Systems

Advanced MIG
Welding Systems 

Software-Driven Multi-MIG® Process Platform

Quick Specs

Manufacturing Applications

Construction Equipment
Automotive Components
Recreational Vehicles
Farm Machinery
Office Furniture
Mining Machinery

Processes

Multi-MIG®
Accu-Pulse® MIG (GMAW-P)
- Accu-Curve™
- Accu-Speed™ *Optional*
Pulsed MIG (GMAW-P)
MIG (GMAW)
Metal-Cored
RMD® *Optional*
Carbon Arc Gouging (CAC-A)
can also be activated

FREE TRIAL! of Accu-Speed and RMD. See page 2 for details.

Rated Output **300:** 300 A at 29 VDC, 60% Duty Cycle
(225 A at 25.3 VDC, 100% Duty Cycle)
450: 450 A at 36.5 VDC, 100% Duty Cycle
675: 675 A at 38 VDC, 100% Duty Cycle

Voltage Range 10–44 V

Auxiliary Power 120 VAC, 10 A Duplex

Net Weight **300:** 112 lb. (50.8 kg)
450: 163 lb. (73.9 kg)
675: 215 lb. (97.5 kg)

Flexible, Expandable and Upgradeable

Multi-MIG capable welding systems are precise, digitally controlled and software-driven. For additional information see page 2.

Access four-drive-roll wire drive feeder is combined with operator interface leaving no controls back at the power source.

Several different **wire feeding and operator interface options** are available and configurable to desired application.

Access the ability to accommodate welding data file exchange through downloadable upgrades and new hybrid welding processes using e-mail, or the Web and a PC or Palm™ handheld (PDA).

Look for high-speed video clips of Accu-Pulse, Accu-Curve, Accu-Speed and Front Panel Simulator at MillerWelds.com/advanced.



Insight™ Core is a flexible, Internet-based industrial welding information management solution that can help your operation be more competitive and profitable by delivering accurate, decision-ready information about welding processes. See page 2 for more information.



Allows for **any** input voltage hook-up (208–575 V) with no manual linking. Assures rock-solid, consistent output on fluctuating primary lines.

Fan-On-Demand™ only operates when needed, cooling internal components.

1/4-turn steel connectors allow for faster installation of system and eliminates thread stripping.

115 VAC duplex receptacle provides 10 amps of circuit-breaker-protected auxiliary power regardless of primary power.

Access MIGRunner™ Package shown.



Build your own system at MillerWelds.com/equiptoweld or see the **Stationary and MIGRunner Packages** on page 8.



Power source and wire feeder are warranted for 3 years, parts and labor.
Original main power rectified parts are warranted for 5 years.
Gun warranted for 90 days, parts and labor.



Miller Electric Mfg. Co.
An ITW Company
1635 West Spencer Street
P.O. Box 1079
Appleton, WI 54912-1079 USA

Equipment Sales US and Canada
Phone: 866-931-9730
FAX: 800-637-2315
International Phone: 920-735-4554
International FAX: 920-735-4125

MillerWelds.com
  



Insight™ Core

Insight Core is a flexible, Internet-based industrial welding information management solution that can help your operation be more competitive and profitable by delivering accurate, decision-ready information about welding processes — so you can take steps to reduce costs, boost output, increase product quality and improve your bottom line. Visit MillerWelds.com/insight to learn more.



Available factory-installed or as a field option. See page 8 for ordering information.

Access 300, 450 and 675 power sources shown with factory-installed Insight Core option.



Access Insight Core Module field option.



Increase Productivity

Evaluate key indicators of operator productivity

- Measure arc-on time and compare to preset goals
- Measure number of arc starts
- Measure wire deposition



Improve Weld Quality

Measure important indicators of weld quality

- Identify welds outside of preset amperage and voltage thresholds
- Identify operators who may need additional training
- Weld Trace™ provided for every weld



Manage Costs

Monitor and analyze welding costs

- Understand weld cell productivity variations
- Understand the impact of continuous improvement efforts
- Understand wire deposition to determine potential over-welding

Features and Benefits

SOFTWARE (Standard)

FREE 16 Hour Trial of Accu-Speed and RMD with Every New Access® Power Supply

Multi-MIG® capability

Includes common carbon steel, aluminum and stainless welding programs, including Accu-Pulse®, Accu-Curve™ and Accu-Speed™ (optional), standard or adaptive pulse, conventional MIG and metal core programs, and RMD® (optional) using the most popular wire diameters and gas combinations.

SureStart™

Provides consistent arc starts by electronically assuring a ball is not left on the wire when welding is stopped. This provides a predictable condition for the next arc start and combines this with precisely tuned arc starting routines.

Arc Control

Control offers a simple way to tailor factory pulse weld programs by adjusting the arc plasma cone to accommodate a variety of welding applications without the need for any reprogramming or changing any hardware.

Arc Adjust

Allows a simple method that controls arc length for pulse processes and wetting action for RMD.

Remote/trigger program select

Allows changing weld programs to take advantage of up to eight programs of Multi-MIG welding process capabilities.

Optional Access software

Accu-Speed and RMD, Access file management system, and WaveWriter™ pulse wave shaping.

Multi-MIG® Process Capability – Through Software-Based Programs

Access the ideal welding process for any weld joint at hand. Whether you need high travel speed combined with high deposition rates or require gaps to be filled, any combination of the available welding processes can be accessed either at the start of a welding sequence or anywhere in the weld while actually welding by using trigger or remote program select.

For a given wire-feed speed, the chart below shows from left (hottest) to right (coolest) all the possible arc mode transfer ranges of accessible MIG and pulse processes. This shows compatible shielding gas combinations such as 90 Ar/10 CO₂ (90 percent argon and 10 percent carbon dioxide) on steel using the same wire-feed speed and also gives an indication of puddle control characteristics based on arc type selected.

Process	Standard Spray	Pulsed Spray	Accu-Pulse® Accu-Curve™ Accu-Speed™ (Optional)	Standard Short Circuit	RMD® Regulated Metal Deposition (Optional)
Weld Puddle Control	Flat/Horizontal		All Position Performance		Thin Materials/Gap Filling

Note: To achieve optimum performance, 4/0 welding power secondary cable is recommended and the supplied work-sense lead must be connected as close to arc as possible.

Featured Welding Processes

Accu-Pulse® STANDARD on all Axxess® models

The Accu-Pulse process allows for precise control of the pulse arc. Accu-Pulse provides optimum molten puddle control and has power to increase wire feed speeds and deposition 20 to 25 percent in many applications. In most cases, slightly different ratios of gas mixtures will perform well using a similar program and adjusting arc length or the appropriate arc control for the selected process. Contact Miller for more information on less common materials and gas combinations.

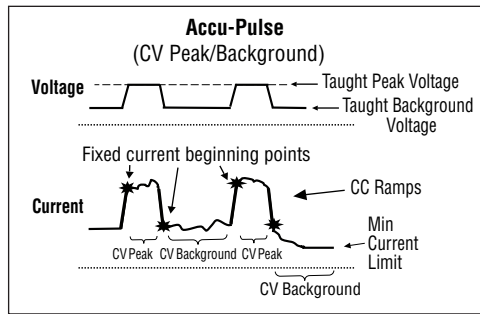

Benefits (Compared to conventional pulse)

- Shorter arc lengths possible
- Better puddle control
- More tolerant of contact tip to work variation
- Less audible noise
- No arc wandering in tight corners
- Narrow arc plasma column
- Allows weld to fill in at toes increasing travel speed and deposition
- More tolerant of poor fit up and gaps (compared to standard pulse)
- Ideal for robot seam tracking applications

Accu-Curve™ STANDARD on all Axxess® models

Accu-Curve is a variation of the Accu-Pulse process. The transitions from peaks to background voltage are “curved”. The curved transitions provide a “softer” feel without sacrificing the tight arc lengths that allow for better puddle control and have become the hallmark of the Accu-Pulse process.

Note: Accu-Curve can be added to existing Axxess systems for FREE by updating code online at MillerWelds.com/advanced. Requires Palm handheld or PC to transfer code to Axxess.

Benefits

- “Softer” arc feel than Accu-Pulse
- Maintains tight arc lengths
- Maintains better puddle control

Optional Software-Based Welding Processes

Accu-Speed™

Field #300 719 For Palm (Required Palm handheld with data card slot is NOT included.)

Field #300 720 For PC (PC-based emulator and cable are NOT included.)

Accu-Speed is a variation of the Accu-Pulse process and was developed for the type of arcs needed in automated welding applications. Accu-Speed has a tighter driving arc that can be directed into the joint, yet still remains stable at the higher travel speeds used in automated welding. In general, Accu-Speed has lower average voltage and amperage when compared to Accu-Pulse which makes it ideal when welding out of position in the manual mode.

Note: Serial number must be provided for field installation. Factory-installed software can be ordered as a combo-number option with power supply. See power source stock number listings on page 8. Field kits include cable for connecting to Axxess, but require PC Palm handheld or PC version of File Manager.

Benefits

- Up to 20% greater travel speed than Accu-Pulse
- Lower average voltage/amperage than Accu-Pulse
- Tight, driving arc
- Remains stable at higher travel speeds

RMD® (Regulated Metal Deposition)

Field #195 252 For Palm (Required Palm handheld with data card slot is NOT included.)

Field #300 721 For PC (PC-based emulator and cable are NOT included.)

The RMD process is a precisely controlled short-circuit transfer. It is a method of detecting when the short is going to clear and then rapidly reacting to this data changing the current (amperage) levels. Features proactive dynamic puddle control.

Note: Serial number must be provided for field installation. Factory-installed software can be ordered as a combo-number option with power supply. See power source stock number listings on page 8. Field kits include cable for connecting to Axxess, but require PC Palm handheld or PC version of File Manager.

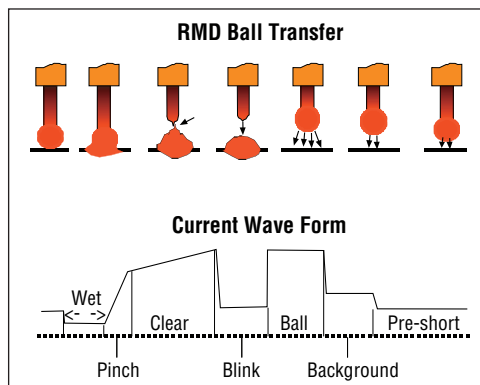

Benefits

- Well suited to thin materials
- Can replace TIG process in some applications
- Gap filling
- Spatter reduction
- Provides less heat into work piece
- Excellent performance on stainless steel
- Can be combined with other Axxess®-related programs
- Minimize distortion
- Use larger diameter wire on thin materials

Typical Installations (Semi-automatic Pulsed MIG or conventional MIG)

The Access platform is designed to provide multiple wire feeding configurations suited to the unique needs of modern manufacturing applications and industries. It utilizes many common components to minimize both part and maintenance complexity. All motors operate on 40 VDC provided by the Access power supply and have a wire feed speed range of 50–1400 inches per minute. A common operator interface is used on all (see page 6).

Standard Installation

A typical bench/sled feeder installation. For use when the feeder is placed on the power supply, a bench or an optional cart.

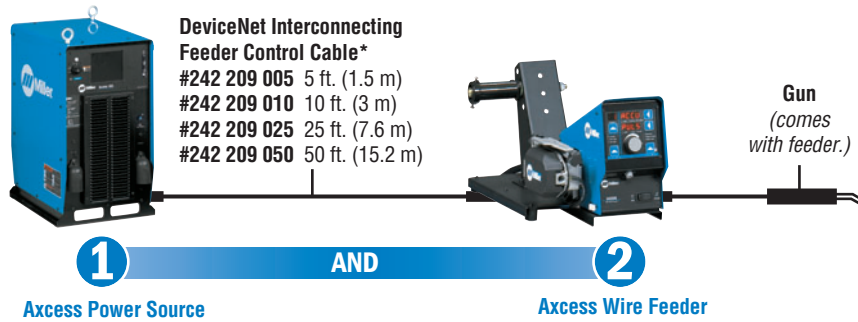

**For available lengths visit MillerWelds.com/equiptoweld.*

- DeviceNet Interconnecting Feeder Control Cable***
- #242 209 005 5 ft. (1.5 m)
 - #242 209 010 10 ft. (3 m)
 - #242 209 025 25 ft. (7.6 m)
 - #242 209 050 50 ft. (15.2 m)

ROI Option Installation

Allows feeder motor drive to be placed away from power supply and operator interface. Ideal for fixed automation applications and updating or replacing equipment on booms or other applications where separate location of power source, ROI, and wire drive motor is desirable.

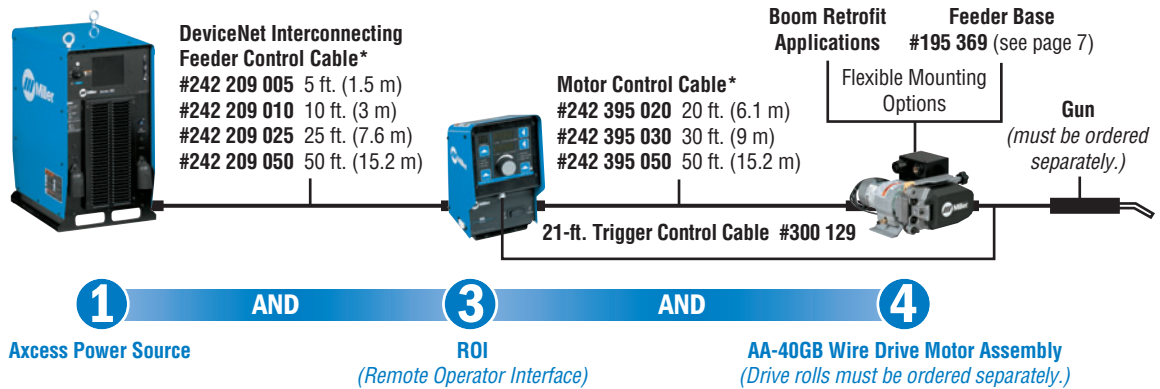

- DeviceNet Interconnecting Feeder Control Cable***
- #242 209 005 5 ft. (1.5 m)
 - #242 209 010 10 ft. (3 m)
 - #242 209 025 25 ft. (7.6 m)
 - #242 209 050 50 ft. (15.2 m)

- Motor Control Cable***
- #242 395 020 20 ft. (6.1 m)
 - #242 395 030 30 ft. (9 m)
 - #242 395 050 50 ft. (15.2 m)

Boom Retrofit Applications **Feeder Base #195 369** (see page 7)

Flexible Mounting Options

Gun (must be ordered separately.)

21-ft. Trigger Control Cable #300 129

1 Power Source Specifications (Subject to change without notice.)



Model	Amp/Volt Ranges	Rated Output	Amps Input at Rated Output, 50/60 Hz, 3-Phase								Max. Open-Circuit Voltage	Dimensions	Net Weight
			208 V	230 V	400 V	460 V	575 V	V	KVA	KW			
Access 300	5–400 A, 10–44 V	300 A at 29 VDC, 60% duty cycle (225 A at 25.3 VDC, 100% duty cycle)	33	29.7	16.9	14.6	11.6	11.7	11.2	80 VDC	300 H: 23 in. (584 mm) 450 H: 31 in. (787 mm)	112 lb. (50.8 kg)	
Access 450	5–600 A, 10–44 V	450 A at 36.5 VDC, 100% duty cycle	—	60	33.7	28.8	22.8	23.8	22.9	80 VDC	675 H: 39 in. (991 mm) W: 17 in. (432 mm) D: 22.5 in. (572 mm)	163 lb. (73.9 kg)	
Access 675	5–900 A, 10–44 V	675 A at 38 VDC, 100% duty cycle	—	89.7	—	43.7	34.8	35.7	34.4	80 VDC		215 lb. (97.5 kg)	

Certified by Canadian Standards Association to both the Canadian and U.S. Standards.

2 Wire Feeder Options



Feeders include drive rolls and Bernard™ Q-Gun™ (one for single-wire models and two for dual-wire models). Required DeviceNet Interconnecting Feeder Control Cable must be ordered separately.

Access Single Feeder #951 311
Access Dual Feeder #951 431

Feeder is designed specifically for Access power source. Provides single-range control of 50–1400 inches per minute. Dual-wire model provides the same functionality as single-wire version, but is ideal when two different wire types need to be available at the same time. Digitally communicates with Access power source via DeviceNet Interconnecting Feeder Control Cable.

Model	Gas Valve	Type of Input Power	Connection to Power Source	Wire Feed Speed Range**	Wire Diameter Range	Single Feeder Dimensions	Dual Feeder Dimensions	Net Weight (Feeder only)
Access Bench/Sled Feeder	Included	40 VDC (from Access)	DeviceNet Interconnecting Feeder Control Cable* (order separately)	50–1400 IPM (1.3–35.56 MPM)	.035–3/32 in. (0.9–2.4 mm)	H: 14.5 in. (368 mm) W: 12.5 in. (318 mm) D: 27 in. (686 mm)	H: 15 in. (381 mm) W: 19 in. (483 mm) D: 34 in. (863 mm)	Single feeder 46 lb. (21 kg) Dual feeder 87 lb. (39 kg)

**For available lengths visit MillerWelds.com/equiptoweld.*

***This is the wire feed speed range while using MIG. With Pulsed MIG, the wire feed speed range may be more limited.*

3 ROI (Remote Operator Interface) Options

ROI does NOT include AA-40GB wire drive motor assembly, motor control cable or DeviceNet interconnecting feeder control cable. These must be ordered separately.



Single ROI

Dual ROI



Auto ROI back panel showing connections for input and output signals.

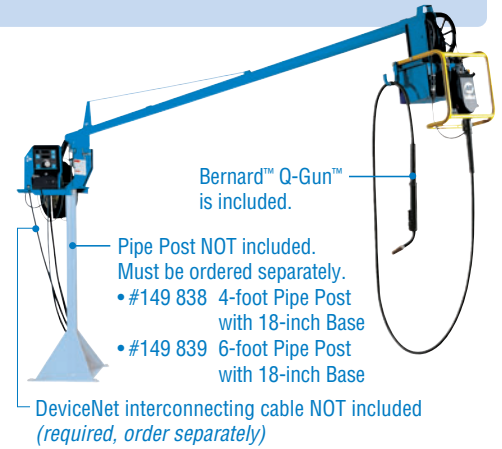

Bernard™ Q-Gun™ is included.

- Pipe Post NOT included. Must be ordered separately.
- #149 838 4-foot Pipe Post with 18-inch Base
- #149 839 6-foot Pipe Post with 18-inch Base

DeviceNet interconnecting cable NOT included (required, order separately)

Single ROI #195 238
Dual ROI #195 433

The ROI allows the Axxess power supply, wire drive motor assembly and operator interface (ROI) to be located in three separate places. This is desirable for mounting to custom jibs, booms or other extended-reach applications. Since an ROI system can incorporate separate components providing the most flexibility for custom applications, it's an ideal way to obtain the many benefits of the Axxess while retaining an existing boom or other structural asset. The dual-wire ROI provides the same functionality as the single, but controls two separate wire drive motor assemblies. Four programs are available per side.

Note: For non-Miller boom and jib mounting, see ROI installation diagram on page 4 and select desired cable lengths.

Auto ROI #195 239*

(Contact Applications for assistance at 920-954-3809 prior to any new installation.)
The Auto ROI is to be used with an Axxess power supply with the E-Stop option. Provides functionality of the ROI, but replaces sequence and trigger functions with two programmable inputs and outputs. To be used in simple dedicated/fixed/hard automation applications. Features arc established output. Includes 30-foot cable for wiring to other external devices.

**Requires Axxess power supply with E-Stop option. E-Stop is not intended for continuous interruption applications. Axxess systems require approximately 30 seconds to reboot or come back online after recovering from an E-Stop condition.*

Note: For non-Miller boom and jib mounting, see ROI installation diagram on page 4 and select desired cable lengths.

Access® ROI Swingarc™ Boom-Mounted Wire Feeders

- #951 383 8-ft. (2.4 m) Single-Wire
 - #951 384 12-ft. (3.7 m) Single-Wire
 - #951 385 16-ft. (4.9 m) Single-Wire
 - #951 386 8-ft. (2.4 m) Dual-Wire
 - #951 387 12-ft. (3.7 m) Dual-Wire
 - #951 388 16-ft. (4.9 m) Dual-Wire
- Swingarc boom-mounted semi-automatic wire feeders bring an extra dimension of flexibility and efficiency to high-production MIG welding stations. You get an effective solution that maximizes output, especially when dealing with large weldments and hard-to-reach places.

Trigger Control Cable #300 129
21 ft. (6.4 m). Required when retrofitting non-Miller booms with an ROI option.

Model	Type of Input Power	Connection to Motor	Connection to Power Source	Single ROI Dimensions	Dual ROI Dimensions	Net Weight
ROI	Supplied from power source	Motor Control Cable* (order separately)	DeviceNet Interconnecting Feeder Control Cable* (order separately)	H: 13 in. (330 mm) W: 7 in. (178 mm) D: 7 in. (178 mm)	H: 13 in. (330 mm) W: 9 in. (229 mm) D: 10 in. (254 mm)	Single ROI 10.5 lb. (4.8 kg) Dual ROI 13 lb. (5.9 kg)

*For available lengths visit MillerWelds.com/equiptoweld.

4 Wire Drive Motor Assembly Options (To be used with Remote Operator Interface.)



AA-40GB Wire Drive Motor Assembly

#195 426 Left-Hand Drive
#195 515 Right-Hand Drive

The AA-40GB wire drive motor assembly with Over Current Protection (OCP) is an improved version of the AA-40G. The motor control cable now mounts directly to the gas box, reducing strain on the tachometer wires. OCP provides

another layer of protection in the event a cable is damaged or shorted, reducing downtime and motor damage. Motors include a 50-foot (15.2 m) volt-sense cable.

Note: Wire drive motor assemblies do NOT include drive rolls or required Motor Control Cable. These must be ordered separately. Left- and right-hand drives are determined by facing the wire feed gun outlet.

Model	Gas Valve	Type of Input Power	Connection to Power Source	Wire Feed Speed Range**	Wire Diameter Range	AA-40GB Dimensions	Net Weight
AA-40GB	Included and enclosed	40 VDC (from Axxess)	Motor Control Cable* (order separately)	50–1400 IPM (1.3–35.56 MPM)	.035–3/32 in. (0.9–1.6 mm)	H: 8 in. (203 mm) W: 12 in. (305 mm) D: 10 in. (254 mm)	16.5 lb. (7.5 kg)

*For available lengths visit MillerWelds.com/equiptoweld.

**This is the wire feed speed range while using MIG. With Pulsed MIG, the wire feed speed range may be more limited.

Control Panels

Front Panel

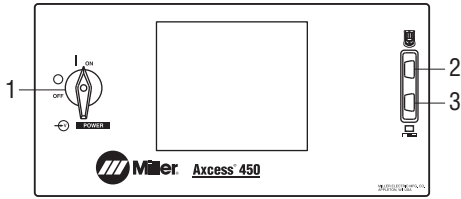

Rear Panel

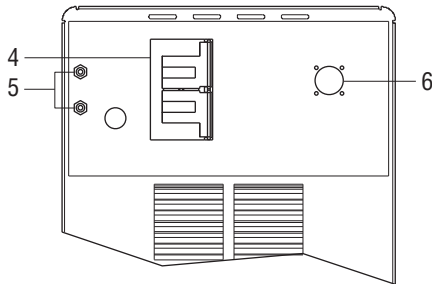

1. Power Switch
2. Handheld RS-232 Port
3. PC-Communication RS-232 Port
4. 115 VAC, 10 A Duplex Receptacle
5. Circuit Breakers
6. Network Feeder Connector

Single Access Feeder and Remote Operator Interface (ROI)

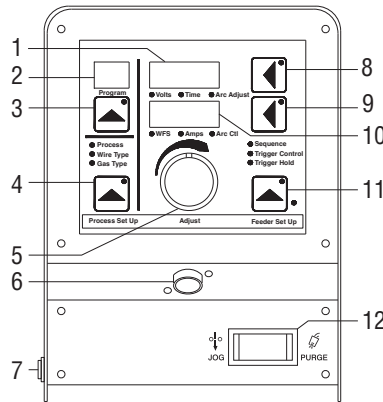

1. Voltage/Arc Adjust Display Meter
2. Program Display
3. Program # Select
4. Process Setup Button
5. Control Knob
6. Trigger Receptacle
7. On/Off Button
8. Voltage Setup Button
9. Wire Speed Setup Button
10. Wire Speed/Amperage Display Meter
11. Feeder Setup Button
12. Jog/Purge Switch

Capabilities

Dual Schedule—Toggle between two settings using a single wire.

4T—When trigger is released, output will operate at different ranges.

Trigger Program Select (TPS)—Provides the ability to access any of the Multi-MIG® processes or any of the eight active programs.

Trigger Dual Schedule (TDS)—When activated, allows selection between predetermined program pairs (e.g. 1,2 – 3,4 – 5,6 – 7,8).

Trigger Hold (TH)—When activated, allows gun trigger release and continuous welding until trigger is pulled again.

Carbon Arc Gouging (CAC-A)—Can be activated.

Sequence

- Preweld: 0.1–5 seconds
- Start Power: 0.1–5 seconds
- Crater: 0.1–5 seconds
- Postflow: 0.1–5 seconds

Arc Adjust—Arc length (Trim)

Arc Control—Arc force or focus (SharpArc®)

Process Selection—Accu-Pulse®, Pulsed MIG, MIG, Metal Core, RMD® (Optional)

Drive Roll Kits and Guides (Order from Miller Service Parts.)

Select drive roll kits from chart below according to type and wire size being used. Drive roll kits include four drive rolls, necessary guides and feature an anti-wear sleeve for inlet guide.

Wire Size	"V" groove for hard wire	"U" groove for soft wire or soft-shelled cored wires	"V" knurled for hard-shelled cored wires	"U" clogged for extremely soft wire or soft-shelled cored wires (i.e., hard facing types)	"U" groove for aluminum wires contains nylon guides
.035 in. (0.9 mm)	#151 026	—	#151 052	—	#243 233
.040 in. (1.0 mm)	#161 190	—	—	—	—
.045 in. (1.1/1.2 mm)	#151 027	#151 037*	#151 053	#151 070	#243 234*
.052 in. (1.3/1.4 mm)	#151 028	—	#151 054	—	—
1/16 in. (1.6 mm)	#151 029	#151 039	#151 055	#151 072	#243 235
.068/.072 in. (1.8 mm)	—	—	#151 056	—	—
5/64 in. (2.0 mm)	—	—	#151 057	—	—
3/32 in. (2.4 mm)	—	#151 041	#151 058	—	—

*Accommodates .045 and .047 (3/64 in.) wire.

Nylon Wire Guides for Feeding Aluminum Wire

Wire Size	Inlet Guide	Intermediate Guide
.035 in. (0.9 mm)	#221 912	#242 417
.047 in. (1.2 mm)	#221 912	#205 936
1/16 in. (1.6 mm)	#221 912	#205 937

Note: "U" groove drive rolls are recommended when feeding aluminum wire.

Wire Guides

Wire Size	Inlet Guide	Intermediate Guide
.023–.040 in. (0.6–1.0 mm)	#221 030	#149 518
.045–.052 in. (1.1–1.4 mm)	#221 030	#149 519
1/16–5/64 in. (1.6–2 mm)	#221 030	#149 520
3/32–7/64 in. (2.4–2.8 mm)	#229 919	#149 521

Consulting Services

Field Application Support #195 480

Access systems may require factory-trained technical support depending on the complexity of the application and the local availability and capability of qualified welding engineers or technology experts. Contact the factory with questions. Factory support is available at a flat rate of \$1250.00 per day (plus expenses) when scheduled more than 10 days in advance. With less than 10-day notice, rates may be higher. Rates are based on a 10-hour day, including travel. One day minimum.

File Management Software



Access® File Management #300 529 For PC
(Includes PC-based emulator, USB cable and USB flash drive

with File Management software.)

Simply put, Access File Management software turns a standard Palm handheld (PDA) or PC into a remote pendant control for all Access Systems.

With Access File Management installed on your Palm OS handheld or PC you can:

- E-mail Access files anywhere worldwide
- Configure any Access system as desired
- Configure multiple Access systems exactly the same or any way you choose
- Save and store Access files
- Transfer Access files to computers
- Transfer Access files from machine to machine
- Backup Access files and programs
- Set-up and modify Access welding sequences
- Adjust and store welding program Locks & Limits for restricting or limiting operator access to programs
- Enable Auto-Thread™ feature to program torch length into Access memory. When a combination of purge and jog (or jog and retract) are depressed, the Access feeding system delivers exact programmed length of wire. Great for troubleshooting wire feed speed and loading wire into the system.

DeviceNet Interconnecting Feeder Control Cables*

- #242 209 005 5 ft. (1.5 m)
- #242 209 010 10 ft. (3 m)
- #242 209 025 25 ft. (7.6 m)
- #242 209 050 50 ft. (15.2 m)

These specially designed Electrical Magnetic Interference (EMI) protected and shielded feeder control cables are required, but not included with Access feeders or ROI. Determine length needed and order separately.

*For additional lengths visit MillerWelds.com/equiptoweld.

Motor Control Cables*

- #242 395 020 20 ft. (6.1 m)
- #242 395 030 30 ft. (9 m)
- #242 395 050 50 ft. (15.2 m)

Includes overmolded connections on high-flex cables for optimal service life.

*For additional lengths visit MillerWelds.com/equiptoweld.

Volt-Sense Cable*

- #242 212 050 50 ft. (15.2 m)

*For additional lengths visit MillerWelds.com/equiptoweld.



Running Gear Cylinder Rack #300 408

For Access 300 and 450 models. Holds two large gas cylinders and has gun cable hangers and a consumable drawer in front for easy access. A convenient handle allows the cart to be pulled easily

through doorways. System components including power source and single or dual feeders can be mounted to the cart and secured.



Industrial MIG 4/0 Kit #300 390

Consists of flowmeter regulator with 10-foot (3 m)

gas hose, 10-foot (3 m) 4/0 feeder weld cable with lugs, and 15-foot (4.6 m) work cable with 600-amp C-clamp.

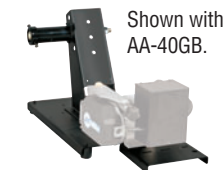

Shown with AA-40GB.

Access® Feeder Base and Spool Support #195 369

Sheet metal construction. Allows mounting of AA-40GB motor

(if desired) when using ROI option or when using an Auto-Access™ with Smart Cable adapter.

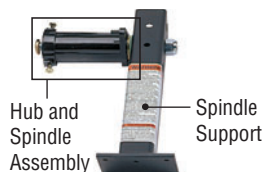

Hub and Spindle Assembly #072 094

Spindle Support #092 989



Spool Cover #057 607



Wire Reel Assembly #108 008

Reel Cover #195 412

For 60-pound (27 kg) coil. Helps to protect the welding wire from dust and other contaminants.

Note: Reel and Spool Covers cannot be installed if the wire drive assembly is in a rotated position.

Turntable Assembly #146 236

Allows rotation of the feeder as the operator changes work positions. Reduces strain and bending on the gun cable.

Hanging Bail (Electrically Isolated) #058 435

Used for suspending feeder over work area.

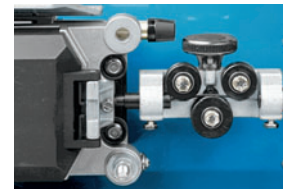

Wire Straightener

#141 580 For .035–.045 in. (0.9–1.1 mm) wire.

#141 581 For 1/16–1/8 in. (1.6–3.2 mm) wire.

Helps reduce the cast in wire to improve wire feeding performance and increase the service life of the gun liner and contact tip.

Coolant Systems

For more information, see the Coolmate Series literature sheet, Index No. AY/7.2.

Coolmate™ 3

#043 007 115 VAC

#043 008 230 VAC

For use with water-cooled torches rated up to 500 amps. Unique paddle-wheel indicator, external filter and easy-fill spout.

Coolmate™ 4 #042 288 115 VAC

For use with water-cooled torches rated up to 600 amps. Tough molded polyethylene case with carrying handle.

Low Conductivity Coolant #043 810

Sold in multiples of four one-gallon recyclable plastic bottles. Miller coolants contain a base of ethylene glycol and deionized water to protect against freezing to -37° Fahrenheit (-38° C) or boiling to 227° Fahrenheit (108° C).

Ordering Information

Semi-Automatic Equipment Options	Stock No.	Description	Qty.	Price
Access® 300	#907 150	Power source only		
	#907 150-00-1	Power source with Accu-Speed software upgrade		
	#907 150-01-1	Power source with RMD software upgrade		
	#907 150-00-2	Power source with Insight Core upgrade		
Access® 450	#907 152	Power source only		
	#907 152-00-1	Power source with Accu-Speed software upgrade		
	#907 152-01-1	Power source with RMD software upgrade		
	#907 152-00-2	Power source with Insight Core upgrade		
Access® 675	#907 154	Power source		
	#907 154-00-1	Power source with Accu-Speed software upgrade		
	#907 154-00-2	Power source with Insight Core upgrade		
Access® Insight Core™ Module	#301 081	Field. Adds Insight Core capabilities to Access power sources		
Access® 300 Stationary Package	#951 227	Power source, bench feeder, Bernard™ Q-Gun™, and Industrial MIG 4/0 kit		
Access® 300 MIGRunner™ Package	#951 226	Power source, bench feeder, Bernard™ Q-Gun™, Industrial MIG 4/0 kit and running gear/cylinder rack		
Access® 450 Stationary Package	#951 229	Power source, bench feeder, Bernard™ Q-Gun™, and Industrial MIG 4/0 kit		
Access® 450 MIGRunner™ Package	#951 228	Power source, bench feeder, Bernard™ Q-Gun™, Industrial MIG 4/0 kit and running gear/cylinder rack		
Note: Other power sources are available. Consult factory at 1-920-954-3809 for power sources with E-Stop option.				
Wire Feed Options (see page 4 and 5)		See page 4 for connection diagram and required cables		
Access Feeder	#951 311	Single-wire feeder. <i>Order DeviceNet Interconnecting Feeder Control Cable separately</i>		
	#951 431	Dual-wire feeder. <i>Order DeviceNet Interconnecting Feeder Control Cable separately</i>		
ROI	#195 238	Single-wire model		
	#195 433	Dual-wire model		
Auto ROI (see note above)	#195 239	Requires power source with E-Stop option — consult factory at 1-920-954-3809		
Access ROI Swingarc™ Boom		See page 5 for various models		
AA-40GB Wire Drive Motor Assembly	#195 426	Left-hand wire drive assembly		
	#195 515	Right-hand wire drive assembly		
Drive Roll Kit and Guides		See page 6. Required for AA-40GB Wire Drive Motor Assembly		
Installation Cables				
Trigger Control Cable (21 ft./6.4 m)	#300 129	See page 5. See page 4 for connection diagram		
DeviceNet Communication Cables		See page 7. See page 4 for the connection diagram		
Motor Control Cable		See page 7. See page 4 for the connection diagram		
Volt-Sense Cable (50 ft./15.2 m)	#242 212 050	<i>Included with drive motor. See page 7</i>		
Optional Software-Based Welding Processes				
Accu-Speed™	#300 719	For Palm. Field (<i>required Palm™ handheld is NOT included</i>)		
	#300 720	For PC. Field (<i>required PC-based emulator and cable are NOT included</i>)		
RMD® (Regulated Metal Deposition)	#195 252	For Palm. Field (<i>required Palm™ handheld is NOT included</i>)		
	#300 721	For PC. Field (<i>required PC-based emulator and cable are NOT included</i>)		
Services and Options				
Field Application Support	#195 480	One day minimum, not subject to discount. See page 7		
Access® File Management Software	#300 529	For PC. File management software (<i>PC-based emulator is included</i>)		
WaveWriter™ Wave Shaping Software	Consult factory	For PC. File management software with wave shaping (<i>PC-based emulator is included</i>)		
Accessories				
Running Gear Cylinder Rack	#300 408	For 300 and 450 models only. Holds two cylinders, cooler, machine and feeder		
Industrial MIG 4/0 Kit	#300 390	Includes flowmeter regulator with 10-ft. (3 m) gas hose, 10-ft. (3 m) 4/0 feeder weld cable with lugs, and 15-ft. (4.6 m) work cable with 600-amp C-clamp		
Access Feeder Base and Spool Support	#195 369	Allows mounting of AA-40GB motor when using ROI option		
Hub and Spindle Assembly	#072 094			
Spindle Support	#092 989			
Additional Feeder Accessories		See page 7		
Coolant Systems		See page 7		

Date:

Total Quoted Price

Distributed by:

